

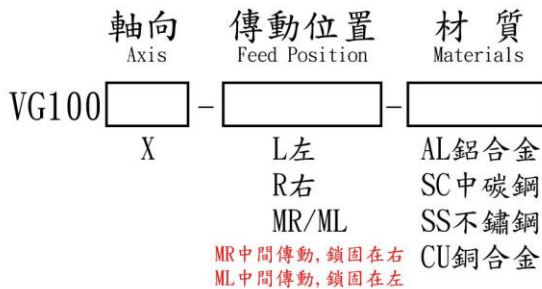

得豐實業有限公司

Dfwisdom Industrial CO., LTD

VG100X 系列(單軸交叉滾子精密滑台)



規格特性 Specifications Characteristics

型號 Model	VG100X-L	VG100X-MR/ML	VG100X-R
枱面尺寸 Table Size	100 x 100 mm		
分厘卡測頭位置 Use Position	左 L	MR/ML	右 R
移動行程 Stroke	±12.5 mm		
移動真直度 Straightness	30 μm		
移動水平度 Motion Horizontal	30 μm		
移動俯仰度 Pitching	30"		
移動橫擺度 Yawing	20"		
檯面平面度 Horizontal	30 μm		
檯面平行度 Parallelism	30 μm		
水平耐荷重 Horizontal Allowable Loading	15 kg		
垂直耐荷重 Vertical Allowable Loading	6 kg		
最大保持力 Allowable Holding	12 kg		
重量 Weight	0.7 kg		
材質 Material	鋁合金AL / 中碳鋼SC / 不鏽鋼SS / 銅合金CU		
表面處理 Surface Treatment	黑色鍍鉻 / 黑色陽極氧化 / 電鍍化學鍍		



VG100X 系列(單軸交叉滾子精密滑台)

VG100X-L DIMENSION

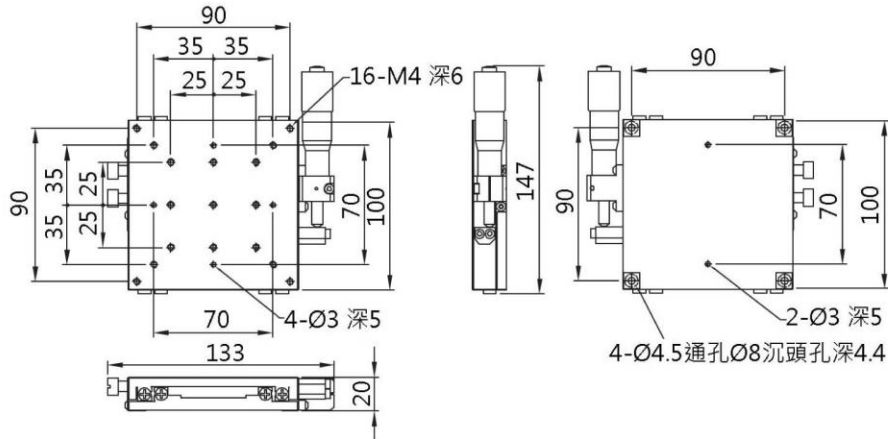

VG100X-MR DIMENSION

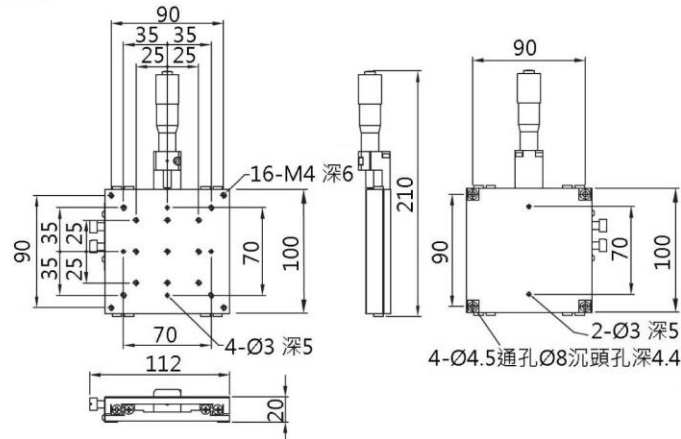

VG100X-R DIMENSION

